



# BIC-e

Beachcomber Improving Customer's Experience

## TechBook

### in.touch 2

\*Instructions for Beachcomber Hybrid4 Hot Tub  
with factory installed in.touch 2 Spa Transmitter

ultimate Wi-Fi remote control for your hot tub



Simplest of setups

---

Strong and long range communication signal

---

State-of-the-art apps with push notifications





---

## Table of contents

Warning .....	2
Introduction .....	3
Overview	
- in.touch 2 overview .....	4
- in.touch 2 dimensions .....	4
Installation and connections	
-in.touch 2 Spa Transmitter (CO Module) installation *Beachcomber Hybrid Factory Installed* .....	5
- Home Transmitter (EN Module) installation (" <i>how-to</i> " video) .....	6
-Connection of the Home Transmitter (EN Module) .....	6
LED Status .....	7
Application .....	8
-Download application .....	8
-Using the app .....	8
-Setup your Wi-Fi on your device .....	9
-Start the in.touch 2 application .....	10
-Login screen .....	11
-New account creation (" <i>how-to</i> " video) .....	11
-Select a spa (" <i>how-to</i> " video).....	12
-Home screen .....	12
-Spa state .....	13
-Change temperature .....	13
-Turn on/off accessories .....	14
-Turn on/off the lights .....	14
-Filter Mode.....	15
-Modifying schedules .....	16
-Reminders .....	17
-Spa Settings.....	18
-in.touch network .....	18
-Change channel .....	19
-Temperature units .....	19
-Name .....	20
-Technical Info .....	20
-Settings .....	21
-Add a spa .....	21
-Account .....	22
-Lock your hot tub keypad .....	22
-Technical Support invitation .....	23
-Authorizing an invitation .....	23
-Dealer screen .....	24
Troubleshooting .....	25
- Home Transmitter (EN Module) LED status .....	25
- Spa Transmitter (CO Module) LED status .....	26
Pairing	
-Pairing the Spa Transmitter (CO Module) and the Home Transmitter (EN Module) .....	27
Specifications .....	28



## Warning



### **WARNING:**

Before installing or connecting the unit, please read the following.

- \* FOR OPTIMUM PERFORMANCE PLEASE CAREFULLY READ THE MANUAL BEFORE INSTALLATION.
- \* INSTALL THE IN.TOUCH 2-CO MODULE AT LEAST 12" (30 CM) AWAY FROM ANY METAL PART OR ANY METAL FOIL.
- \* THE IN.TOUCH 2-CO MODULE SHOULD BE INSTALLED SUCH AS IT CAN BE RELOCATED UNDER THE SPA IN ORDER TO OBTAIN OPTIMAL RECEPTION AFTER FINAL INSTALLATION OF THE SPA IN THE YARD.
- \* TO SATISFY FCC RF EXPOSURE REQUIREMENTS FOR MOBILE AND BASE STATION TRANSMISSION DEVICES, A SEPARATION DISTANCE OF 8" (20 CM) OR MORE SHOULD BE MAINTAINED BETWEEN THE IN.TOUCH 2 MODULES AND PERSONS DURING OPERATION; TO ENSURE COMPLIANCE, OPERATION AT CLOSER THAN THIS DISTANCE IS NOT RECOMMENDED.
- \* THE ANTENNAS USED FOR THESE MODULES MUST NOT BE CO-LOCATED OR OPERATING IN CONJUNCTION WITH ANY OTHER ANTENNA OR TRANSMITTER.
- \* TO POWER THE IN.TOUCH 2-EN, ONLY USE THE POWER SUPPLY UNIT PROVIDED WITH THE IN.TOUCH 2-EN.
- \* THIS APPLIANCE IS NOT INTENDED FOR USE BY PERSONS (INCLUDING CHILDREN) WITH REDUCED PHYSICAL, SENSORY OR MENTAL CAPABILITIES, OR LACK OF EXPERIENCE AND KNOWLEDGE, UNLESS THEY HAVE BEEN GIVEN SUPERVISION OR INSTRUCTION CONCERNING USE OF THE APPLIANCE BY A PERSON RESPONSIBLE FOR THEIR SAFETY.
- \* CHILDREN SHOULD BE SUPERVISED TO ENSURE THAT THEY DO NOT PLAY WITH THE APPLIANCE.

## DISPOSAL OF THE PRODUCT

THE APPLIANCE (OR THE PRODUCT) MUST BE DISPOSED OF SEPARATELY IN ACCORDANCE WITH THE LOCAL WASTE DISPOSAL LEGISLATION IN FORCE.



## COMPATIBILITY REQUIREMENTS

### **in.touch 2 modules for FCC (North America) models (915 MHz):**

Home and spa transmitter kit: 0608-521020, 0608-521023

### **in.touch 2 modules for ETSI (Europe) models (868 MHz):**

Home and spa transmitter kit: 0608-521021, 0608-521024

### **Compatible spa packs:**

in.xm2, in.xe, in.ye, in.yj and in.yt spa systems manufactured in or after 2012.



### **in.touch 2 application:**

Compatible with devices running:

iOS 8.0 or higher

Android 2.3 or higher

## ROUTER AND INSTALLATION REQUIREMENTS

Any standard router with an available 100 Mbps (wired LAN) RJ45 port can be used. The router must also have its Port 10022 open, which is normally a default setting. A 3-foot (0.9 m) Ethernet cable is included.

The home transmitter will need a main supply (120V in North America, 220V in Europe) nearby to allow connection of the transformer.

Aeware®, Gecko®, and their respective logos are Registered Trademarks of Gecko Alliance Group.

in.touch 2™, in.xm2™, in.xe™, in.yt™, in.ye™, in.therm™ and their respective logos are Trademarks of Gecko Alliance Group.

All other product or company names that may be mentioned in this publication are tradenames, trademarks or Registered Trademarks of their respective owners.



## in.touch 2

Easily integrate your hot tub to the Internet of Things!

### **Simplest of setups**

in.touch 2 eliminates all the complexities of connecting your hot tub to the Internet and transforms your smartphone or tablet into your ultimate Wi-Fi hot tub remote control. in.touch 2 comes with a state-of-the-art app and 2 pre-paired radio frequency transmitters, one being part of your spa system and the second one being connected to your Internet router. Both RF transmitters are pre-linked to one another, enabling an immediate and perfect communication between you and your hot tub.

### **Strong and long range communication signal**

Through their proprietary RF technology, in.touch 2 transceivers emit a strong, stable and long range signal between your hot tub and your router (about 3 times longer than regular Wi-Fi signal). No need for repeaters or boosters: your hot tub will always remain within reach in typical backyard settings.

### **State-of-the-art app with push notifications**

in.touch 2 streamlined application makes it very easy to control and program all the functions and features of your hot tub from your smartphone or your tablet. Even when you're away from home, you get full control of your water care settings, filtration cycles, water temperature, economy modes and a lot more. Push notifications will always keep you informed on the status of your hot tub, even when your app is not open.



## Overview

### in.touch 2 overview

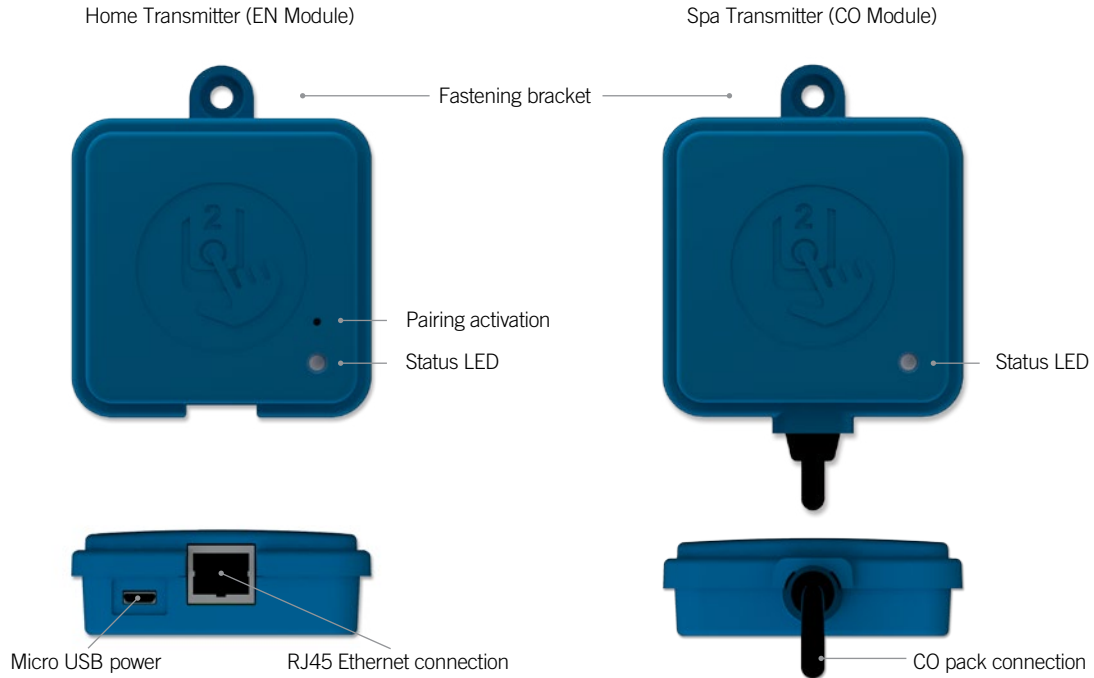

### in.touch 2 dimensions

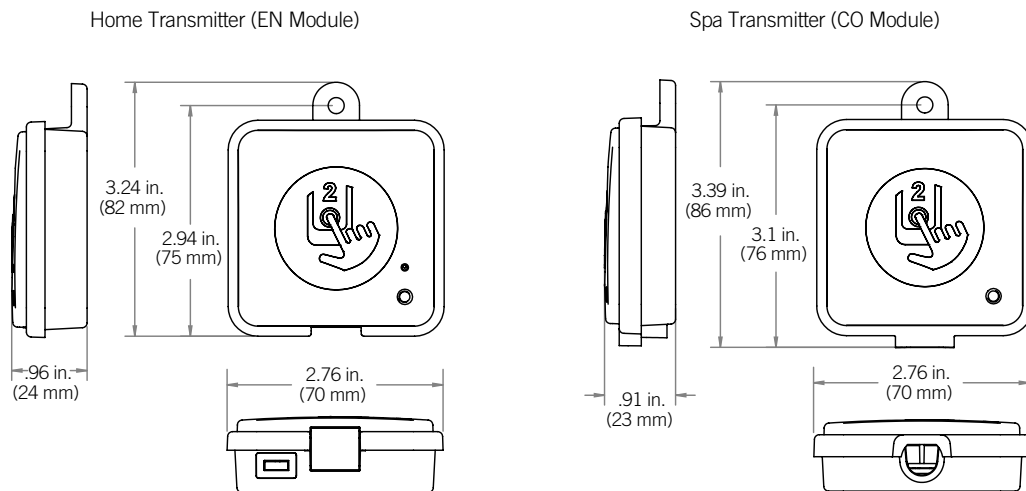

## Installation and connections

### in.touch 2 Spa Transmitter (CO Module) \*Beachcomber Hybrid - Factory Installed\*

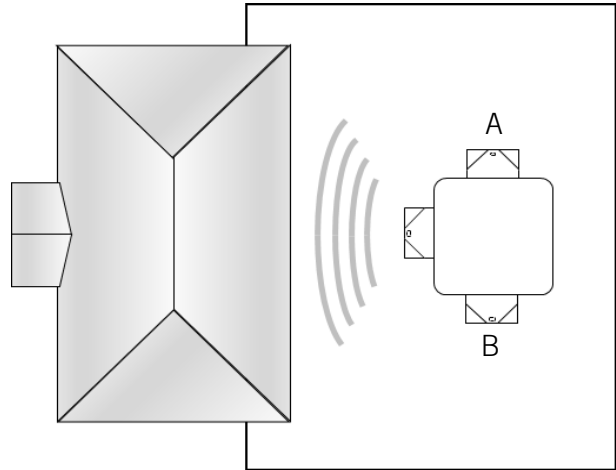

When in.touch 2 is factory installed, the spa transmitter will be mounted on the side of the management system as shown under the Hybrid4 step.

A body of water between the spa transmitter and the Home Transmitter will reduce the signal strength. If possible, position the hot tub so the Hybrid4 step faces towards the home. Option A or B are also acceptable.

Note: It is possible to see the signal strength with the in.touch 2 application in the menu Setting -> in.touch network -> Signal strength.

If required to optimize signal strength, the spa module can be relocated up to 7 feet (215 cm) away from the Management System. See instructions below.

1. Release spa module from its docking location on Management System by lifting the black rubber strap off the head of the screw on the back of the system.
2. Pull out the extra wire supplied from the wire storage pouch on the back of the system.
3. Find a location which is closer and/or in more of a direct line of the house.
4. The screw which held the black rubber strap can be re-purposed to secure the spa transmitter.

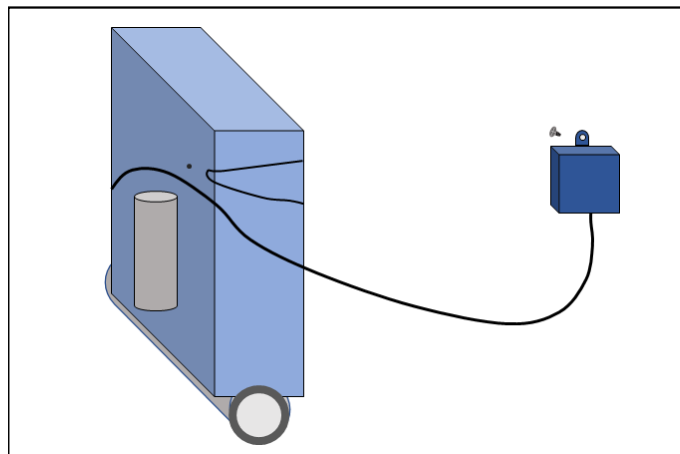
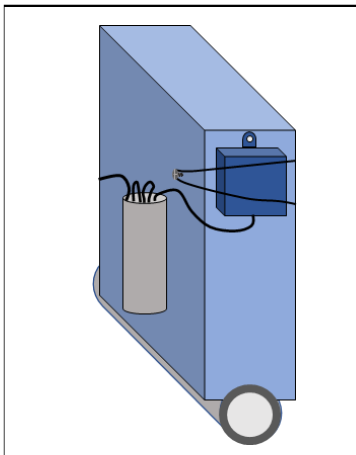

Important - The spa transmitter must be kept protected from weather and direct sunlight.

## Installation and connections

### Home Transmitter (EN Module) installation

#### in.touch 2 "how-to" video:

in.touch 2 - Home installation  
<http://bit.ly/2Uby50htest-InTouch2-HomeInstallation>

The Home Transmitter unit must be installed inside the house near the router as it needs to be connected to it. The Home Transmitter is provided with an Ethernet cable and a power supply. If required, a longer cable of good quality can be used by the installer (longer cable not provided) to install the Home Transmitter closer to the hot tub within the home. The only requirement for installation location is that household current be available to power the Home Transmitter using the provided wall transformer.

The Home Transmitter can be fixed in the house to optimize the signal strength. We recommend that you install the unit with a #8 pan head screw.

Here are some suggestions for a successful installation:

- If possible, install device on the first floor of your house.
- If installing in a basement, place at highest level possible and closest to a window.
- Try to install as far as possible from materials that may interfere with signal (ie. metal structures, thick cement walls).
- Install as far as possible from router as the signal emitted by the antenna may interfere with RF signal.

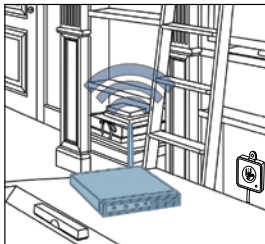

### Connection of the Home Transmitter (EN Module)

Simply connect Ethernet cable into the RJ45 port of the Home Transmitter and in one of the available LAN ports on the router.

Finally, to power up the Home Transmitter, connect the provided transformer to a 120V (North American model) or 220V (European model) household supply and connect the USB cable between the transformer and the Home Transmitter.

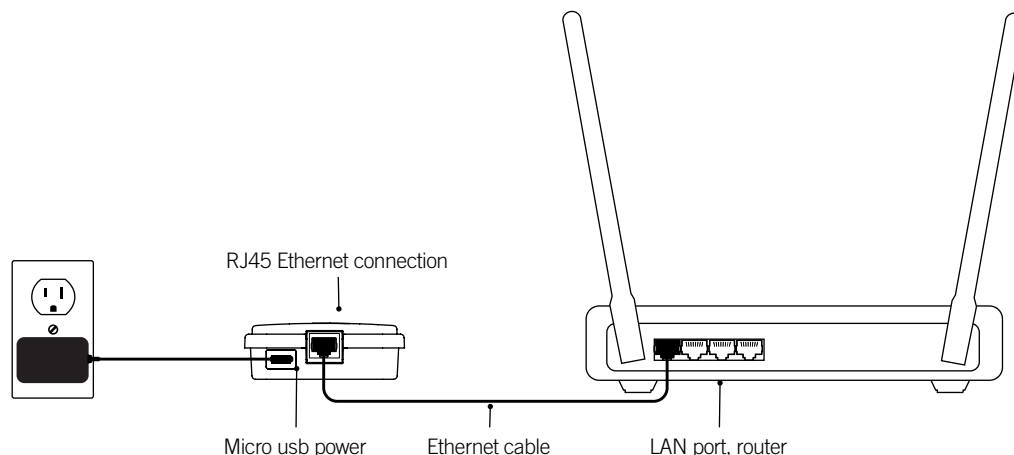



## LED Status

### LED

Each in.touch 2 module has a status LED that can be used for troubleshooting purposes. The LED is located on the top of both enclosures.



#### Home Transmitter

Pairing mode	Yellow (Blinking)
Router not detected	Red
Router detected	Green
in.touch 2 server detected	Blue
Module is fully functional	

#### Spa Transmitter

Pairing mode	Yellow (Blinking)
Spa controller not detected	Red
in.touch 2 server detected	Blue
Module is fully functional	

\* When the LED status is blinking (blue, green or red) this indicates that the communication between the EN module and the CO module is not established.





## Application

### Download application



The in.touch app allows you to control your hot tub using your home network or an Internet connection anywhere in the world. The in.touch 2 app is waiting for you in the App Store for iOS devices and on Google Play for Android — search for «in.touch 2» then click on it to install.

### Using the app

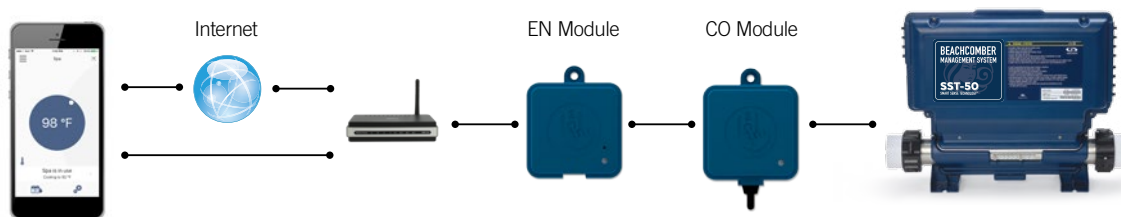

#### On your home network

It is possible to access your hot tub with the in.touch 2 app through your home network. To be able to see your in.touch 2 in the application, you need to connect your device to the same router (Wi-Fi network) that was used to connect your Home Transmitter

Go to the Wi-Fi settings section of your mobile device and choose the same network that your spa is connected to (i.e. Home). Once you've selected it, wait until your device confirms the connection.

#### On the Internet

The in.touch 2 allows you to use the Internet to control your hot tub from anywhere in the world. In order for them to communicate, both the in.touch 2 module and your device must be connected to a network that allows access to the Internet.

Once your Home Transmitter is connected to the Internet (the LED status is blue), you can use your in.touch 2 app any time your device is also connected to the Internet (wireless or cellular network), even if you are away from home.

To have access to your hot tub away from home, you will need to have previously linked your mobile device to your hot tub on your home network.



---

## Application

### Setup your Wi-Fi on your device

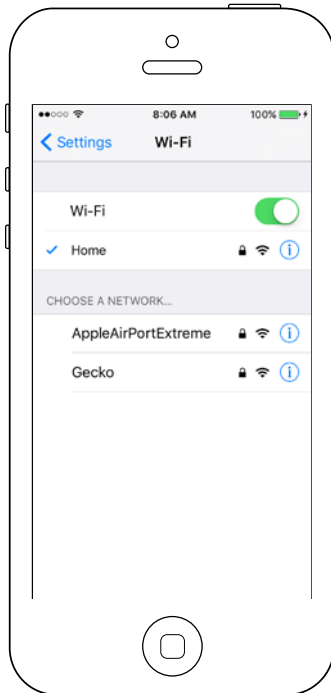

Before using your application, go to the Wi-Fi section of your device's settings. Make sure you are connected to your home network. This needs to be the same Wi-Fi provided by the router to which you connected your Home Transmitter.



## Application

### Start the in.touch 2 application

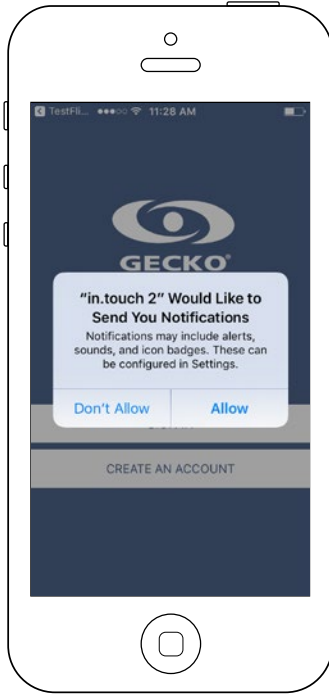

in.touch 2

Find the icon for the in.touch 2 application, then tap on it to open it.

The first time you use the application a message will ask you: “in.touch 2” Would like to send you notifications. If you choose *Allow*, the application will send you notifications about the status of your spa. If you choose *Don't Allow*, the application will not send you notifications.

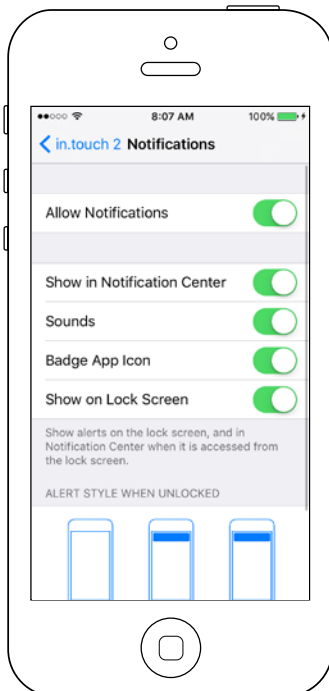

If you change your mind later concerning notifications, you may add or remove notifications for the in.touch 2 application.

On iOS, go in your settings menu and choose in.touch 2. Select the notifications menu, you can turn notifications on or off from this screen.

On Android, go to your settings menu and then into the notifications menu. Select the in.touch 2 app, from this screen you may turn notifications on or off.



## Login screen

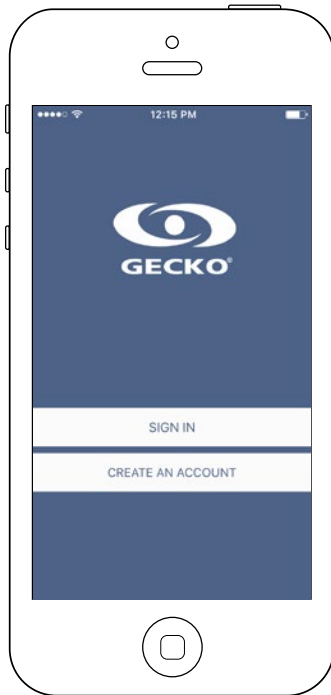

Before using your application, you must create an account first and then, you'll be able to sign in. Your account will give you the opportunity to have access to your hot tub from any in.touch 2 application.

## New account creation

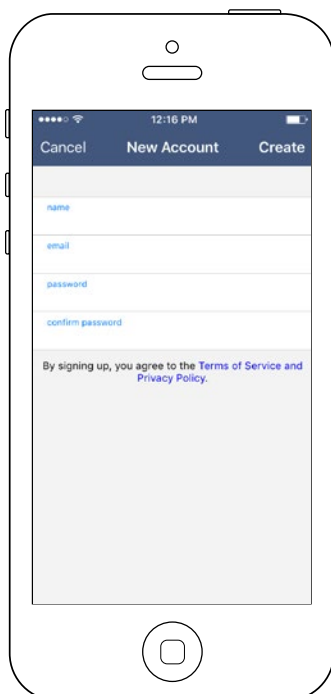

### in.touch 2 "how-to" video:

in.touch 2 - How to create an account  
<http://bit.ly/2uK6Rne-InTouch2-CreateAccount>

When you choose to create a new account, you agree at the same time our Terms of Service and our Privacy Policy. You can read them at any time through this link: <https://geckointouch.com/legal>



## Application

### Select a spa

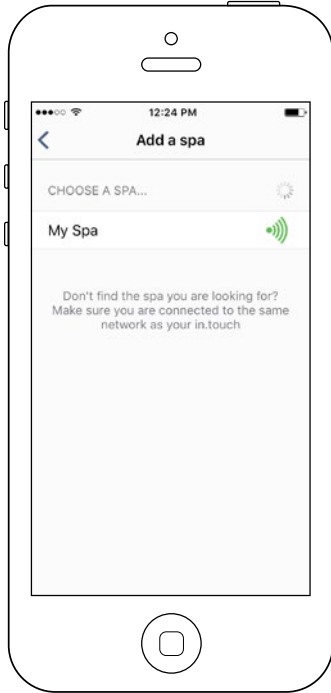

#### in.touch 2 "how-to" video:





in.touch 2 - Select your spa  
<http://bit.ly/2UrWaz7-InTouch2-SelectYourSpa>

**This screen displays all the hot tubs detected by your application. To detect your hot tub, you need to connect your mobile device to the same network to which you connected your Home Transmitter.**

Once you have done a connection with the hot tub its name will be saved on this screen to allow you to connect to this spa from anywhere.

To add a hot tub later on, go to p. 21 of this techbook for instructions.

The RF signal strength (communication between the two in.touch 2 transmitters) is illustrated on the Select a spa screen. There are 5 possible states:

-  • Signal superior to 80%
-  • Signal between 80% and 51%
-  • Signal between 50% and 31%
-  • Signal below 30%
-  • The Spa Transmitter is not available

### Home screen

The main screen gives you access to your accessories, water temperature, water care and settings.

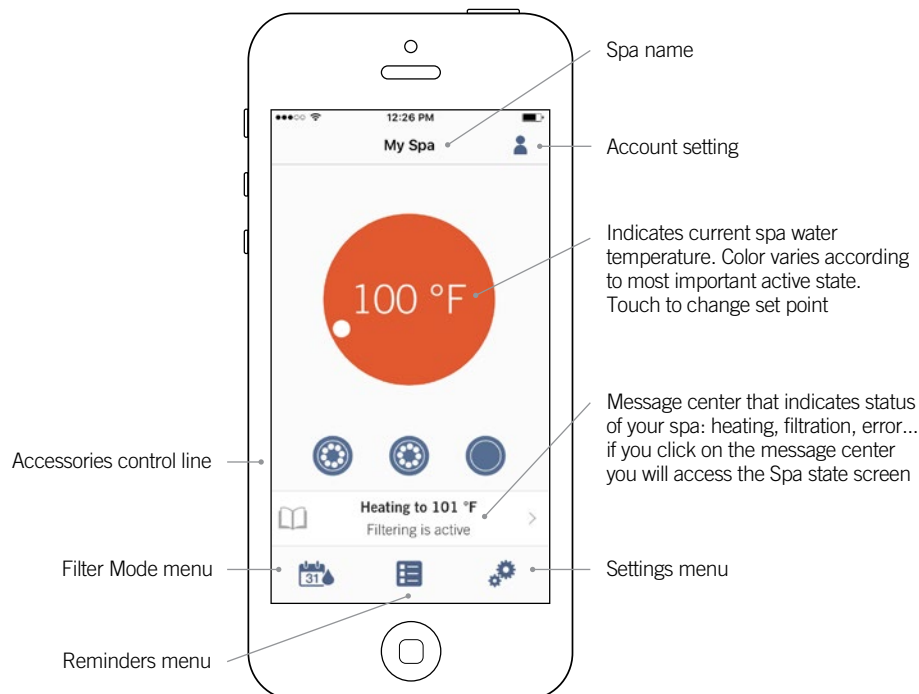

## Application

### Spa state

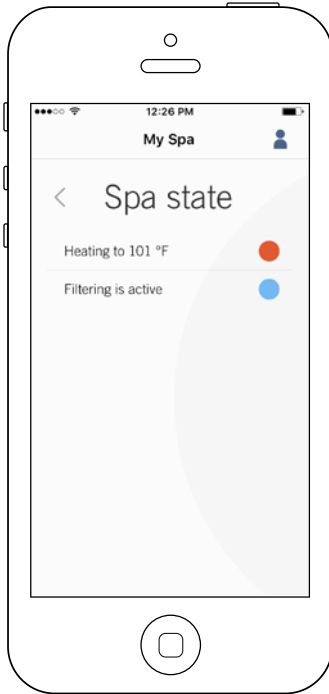

This screen displays all the active states of your hot tub. Below is a quick description of each state you may encounter on your hot tub. Each state is associated to a priority and color that determines the color of the widget on the home screen.

- (Yellow) Indicates that there is an error on your hot tub.
- (Dark blue) Indicates that there is presently an active user demand on your hot tub (ie. pump, blower or light is on).
- (Red) Indicates that your hot tub is now heating to your set point.
- (Blue) Indicates that your hot tub is now in a filtering cycle.
- (Green) Indicates that your hot tub is now in economy mode.
- (Gray) Indicates that your hot tubs is running normally (there is no user demand, heating, no filtration or economy active).

The widget on the home page displays a single color at a time. The color displayed is decided by priority of state. The established priority is as listed above.

### Change temperature

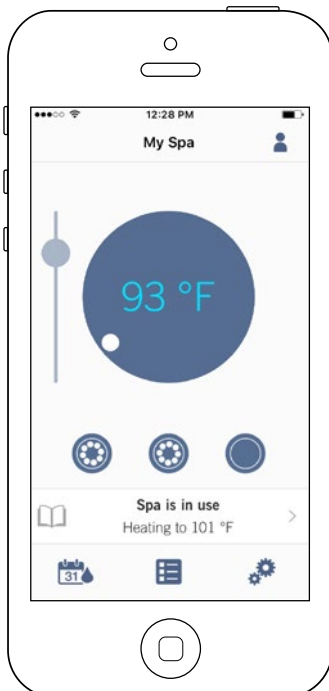

Touch the centered widget to reveal the temperature control bar.

Use the slider on the control bar to change your hot tub's temperature\* set point.

*\* If you are in economy mode your spa temperature will be 20°F below your set point.*



## Application

### Turn on/off accessories

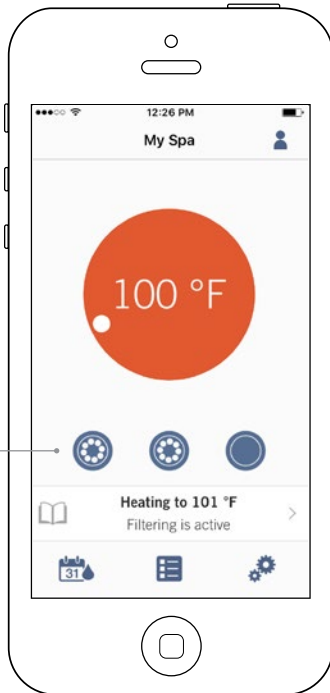

According to your hot tub management system configuration, you can start or stop an accessory by simply touching the associated icon. The icon will become animated when the accessory is on. Simply press on the icon to start or stop the accessory. If your accessory has more than one speed, press the button until the desired speed is reached.

The icon designs are customized according to your management system's configuration:

-  Pump(s)
-  Lights
-  Blower

### Turn on/off the lights

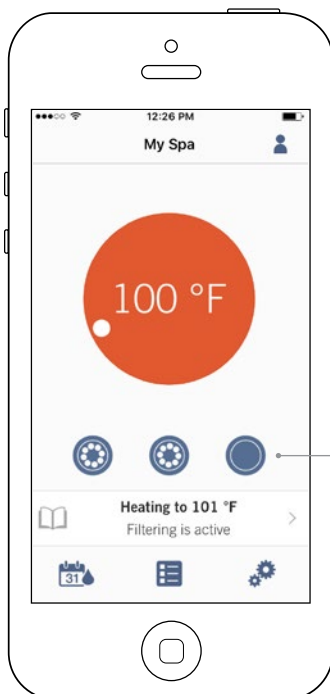

To control your hot tub lights, simply press the button to turn it on or off.



## Application

### Filter Mode

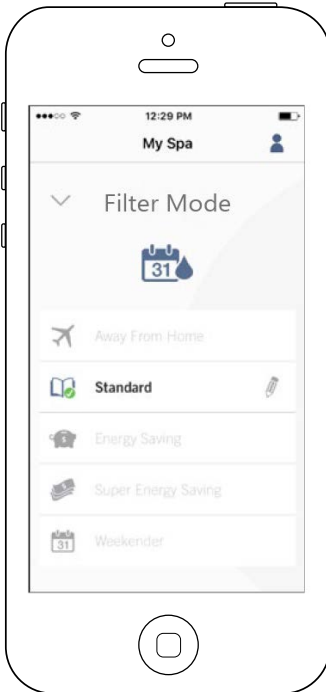

The Filter Mode screen will help you set up your ideal filtration and heating settings. Choose between *Away from Home*, *Beginner*, *Energy Savings*, *Super Energy* and *Weekender*, depending on your need. Touch the Water Care name you would like to activate, a green checkmark will appear on the icon, indicating you have selected it.

By default, each Filter Mode has pre-configured schedules of economy and filtration. To modify Filter Mode options, touch the pencil icon at the right end of the desired Filter Mode to open its menu.

Below you have a short description of each Filter Mode at default state:



#### **Away From Home:**

In this mode the hot tub will always be in economy; the set point will be reduced by 20° F.



#### **\*Standard:**

The hot tub will never be in economy mode and will be filtering according to the pack's low level configuration.



#### **Energy Savings:**

The hot tub will be in economy mode during the peak hours of the day and resume normal mode on the weekend.



#### **Super Energy Savings:**

The hot tub will always be in economy mode during peak hours, every day of the week.



#### **Weekender:**

The hot tub will be in economy mode from Monday to Friday, and will run normally on the weekend.



## Application

### Modifying schedules

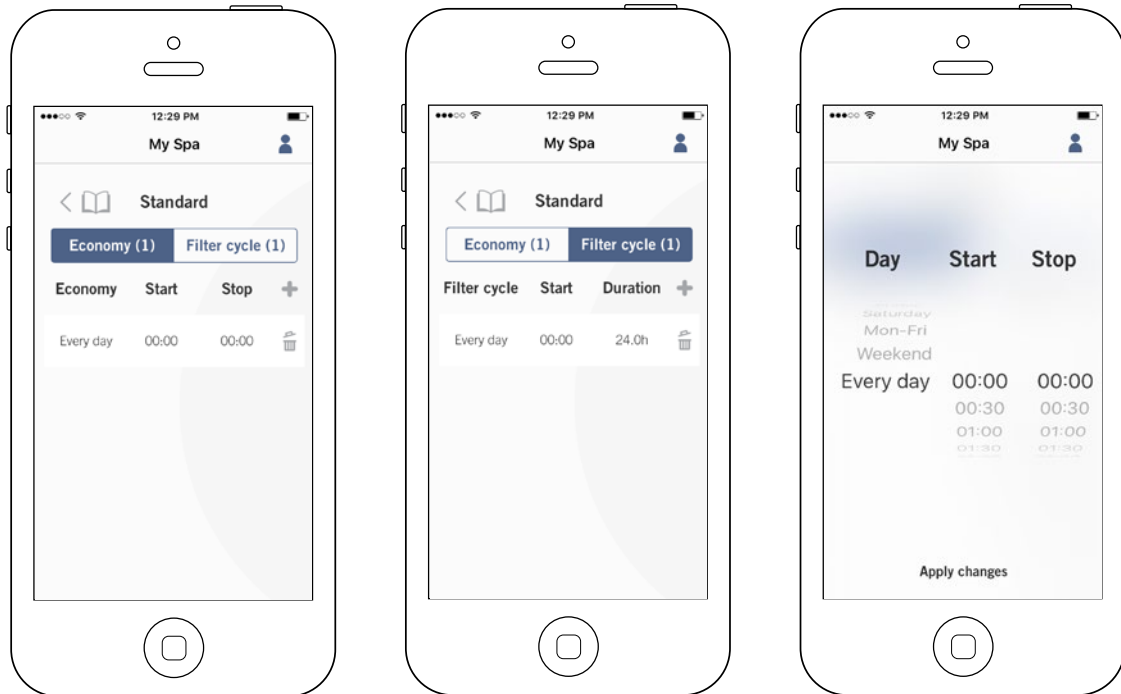

In this menu it is possible to add, remove or edit schedules of economy or filtration.

To have access to this menu, simply touch the tabs:  
Filter Mode menu - the little pen at the right of the wanted filter mode.

**\*Note:** The default Filter Mode for hot tubs equipped with a Hush pump is "Standard" and is programmed to filter 24 hours (2 x 12hr) per day.

Touch the Economy tab to modify the economy schedules and Filter cycle tab for the filtration schedules.  
You can add economy or filtration schedules by touching the « + » symbol.

To delete a schedule, touch the garbage can icon at the right end of the desired line.

You can modify the programmed schedules by selecting one and adjusting the schedule.

You have several possibilities for the schedule (Mon-Fri, weekend, every day, or single days). The schedules will be repeated weekly. The time and duration are set in 30 minute increments. Once you have set the schedule, use the arrow at the top of the page to go back. Ensure that you have selected the desired Filter Mode in the main Filter Mode menu.

When an economy schedule is active, the set point will be reduced by 20°F, which means that the heating system will not be engaged unless the temperature falls to 20°F below the spa's set temperature.



## Application

### Reminders

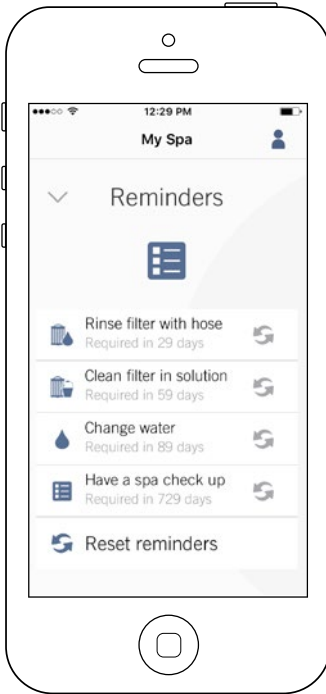

Reminders page will help you to make a follow-up of your maintenance. The in.touch 2 will remember you to perform required maintenance tasks on your hot tub, such as rinse filter or clean filter. Each task has its own reminder duration based on normal use. The owner can reset his reminders after the hot tub maintenance.



## Application

### Spa Settings

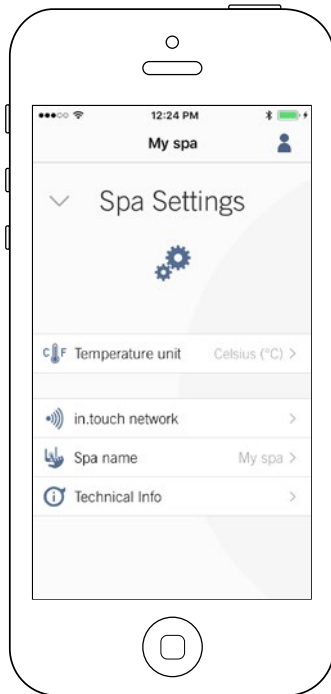

In the Settings screen you can access the following:

- *in.touch network*
- *Temperature units*
- *Change spa name*
- *Technical info*

To select an item, tap on the arrow next to it. It will open the selected menu.

### in.touch network

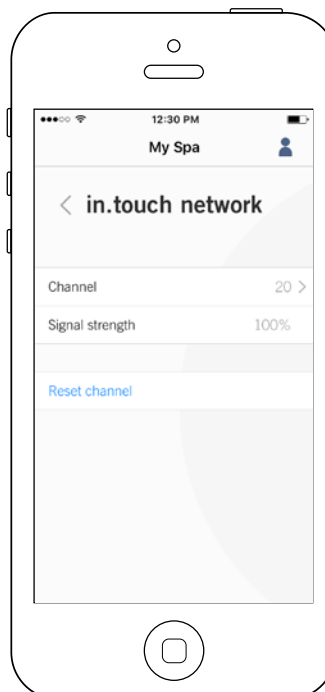
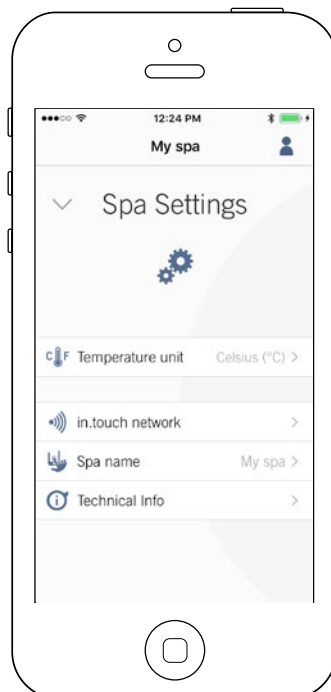

The in.touch network menu allows you to have access to information concerning the RF connection parameters between the Home Transmitter and the Spa Transmitter. This menu gives you access to:

- *Channel*
- *Signal strength*
- *Reset channel (resets channel to ... default)*

To change channels, press on the Channel line.



## Application

### Change channel

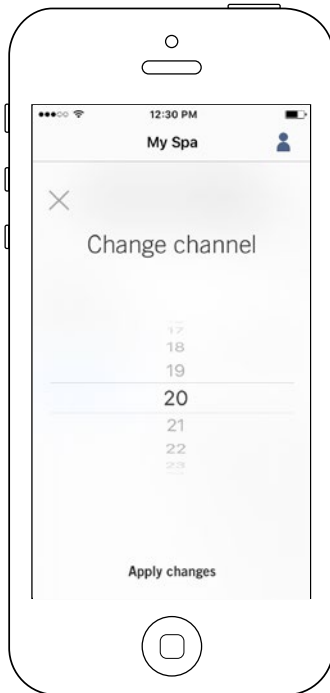

The Change channel screen allows you to change the channel used by the two in.touch 2 modules.

In some cases, this can help you to have a stronger signal.

You can have access to this screen by touching the following tabs:  
Spa settings (at the bottom right) - in.touch network - channel

### Temperature units

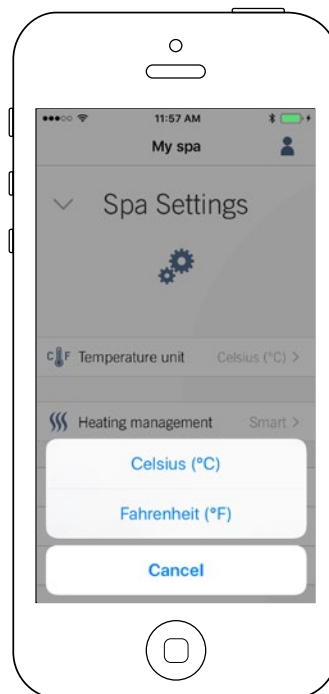
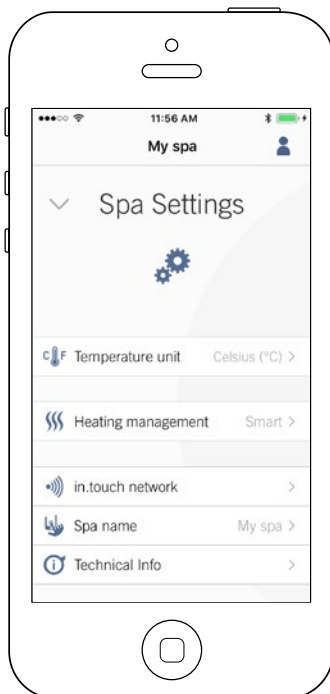

This menu lets you change the units used to display temperature.

You can have access to this screen by touching the following tabs:  
Spa settings (at the bottom right) - temperature units



## Application

### Name

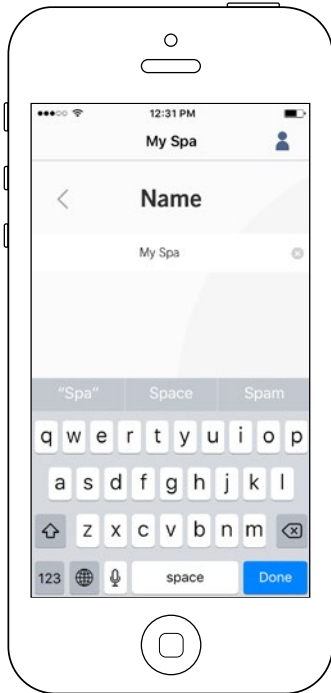

This section allows you to edit the name of the spa.

You can have access to this screen by touching the following tabs: Spa settings (at the bottom right) - Change spa name

### Technical Info



This section shows information about the in.touch 2 software number and the revision numbers of the different components of your system.

You can have access to this screen by touching the following tabs: Spa settings (at the bottom right) - Technical info



# Application

## Settings

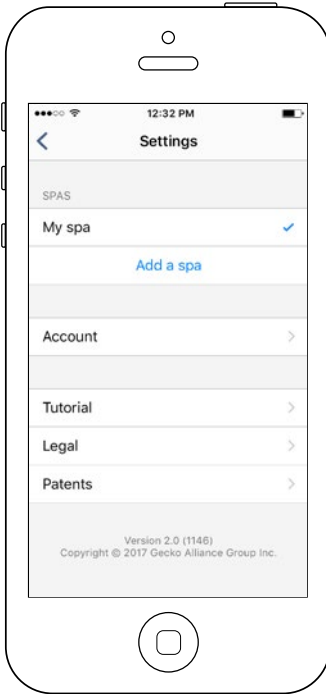

In the Settings screen you can access the following:

- *Add a spa from local network*
- *Account*
- *Tutorial*
- *\*Legal*
- *\*\*Patents*

To select an item, tap on the arrow next to it. It will open the selected menu.

\*The button **Legal** will bring you to this web site : <https://geckointouch.com/legal>

\*\*The button **Patents** will bring you to this web site: <http://geckoport.com/corpo/#patents>

## Add a spa

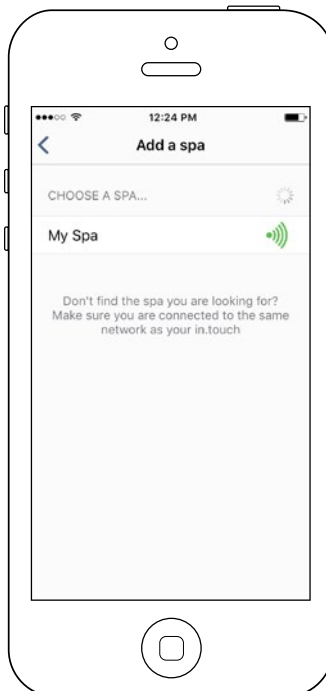





**This screen displays all the spas detected by your application. To detect your spa, you need to connect your mobile device to the same network to which you connected your Home Transmitter.**

Once you have done a connection with the spa its name will be saved on this screen to allow you to connect to this hot tub from anywhere.

You can have access to this screen by touching the following tabs: Settings (up right corner) - Add a spa

The RF signal strength (communication between the two in.touch 2 transmitters) is illustrated on the Select a spa screen. There are 5 possible states:

-  • Signal superior to 80%
-  • Signal between 80% and 51%
-  • Signal between 50% and 31%
-  • Signal below 30%
-  • The Spa Transmitter is not available

## Application

### Account

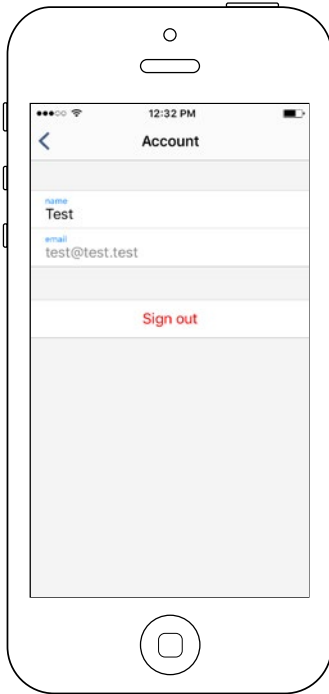

This section gives you access to your account information.

You can have access to this screen by touching the following tabs: Settings (up right corner) - account

### Lock your hot tub keypad

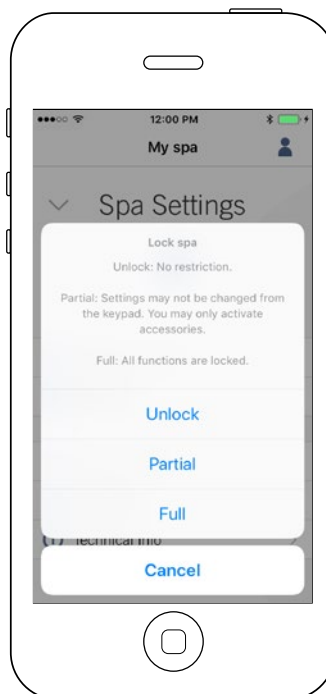
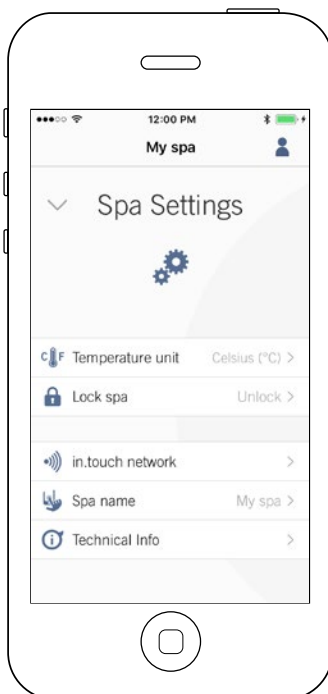

The lock mode menu will appear when the feature is enabled in the low level of your hot tub management system.



## Application

### Technical Support invitation

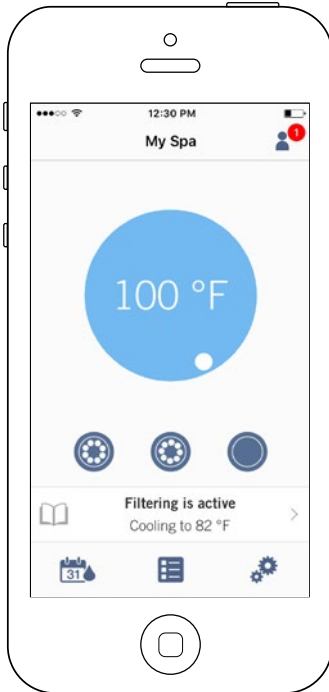

When you receive an invitation for Technical Support, a red circle will be displayed next to the "setting" logo (top right corner).

### Authorizing an invitation

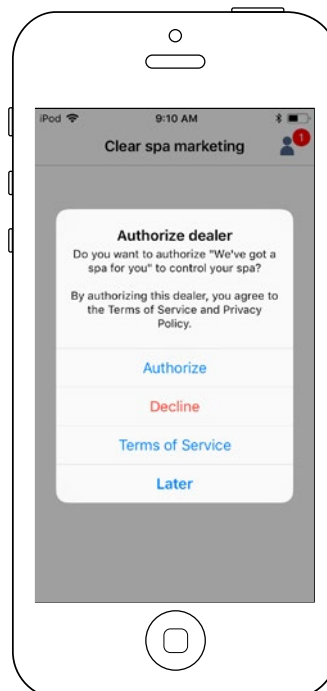
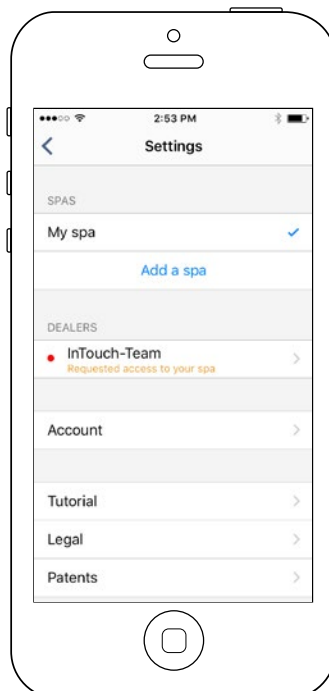

All the invitations you may receive are under the dealers tab in the "settings" menu.

To choose an invitation, simply click on it. You will then see a window authorization to confirm with the dealer's information.

You can also decline the invitation at any time if you want to.





## Application

---

### Dealer screen

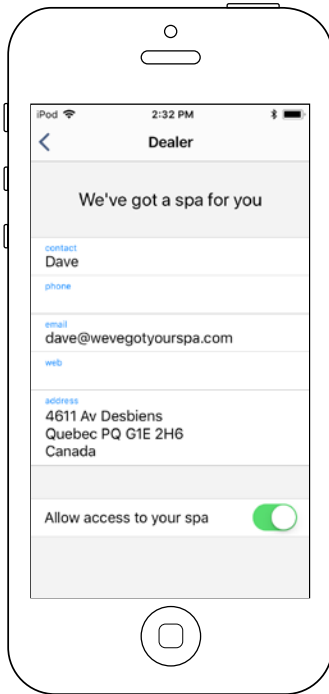

Once you've had a dealer on your in.touch 2 app, you can, at all times, have access to his information.

If you don't want your dealer to have access to your hot tub anymore, simply swap to the left the "Allow access to your spa" button at bottom of the page.



---

## Troubleshooting

Both in.touch 2 modules have a status LED to help diagnose problems, if any occur.

### Troubleshooting

There are 2 different modules in the in.touch 2 kit: The Home Transmitter (EN Module) and the Spa Transmitter (CO Module). They communicate together via an RF link. The Home Transmitter is responsible for the Ethernet communications and the Spa Transmitter is responsible for the hot tub communications.

### Home Transmitter (EN Module) LED status

This module's LED can show various status conditions, as indicated below.

#### Rapidly flashing YELLOW color:

The Home Transmitter is in pairing mode when this color is shown (the pairing switch was pressed). Until a pairing successfully completes, the application cannot connect to the hot tub. To complete the pairing, you must turn off the spa (using its breaker), wait a few seconds and then flip back the breaker to on. The pairing will then occur within a few seconds. If not, then the Spa Transmitter is either incorrectly connected, out of range, or defective.

If the in.touch 2 modules were previously paired and the pairing switch is accidentally pressed, simply unplug the Home Transmitter USB power cord and re-plug it (thereby resetting the Home Transmitter). The modules should then normally reconnect together.

Once out of pairing mode, the Home Transmitter will display another color.

For each of the following colors, the information applies whether the LED is blinking or not. If the LED is blinking, please also refer to the Blinking LED section below.

#### RED color:

##### *Reason?*

The Home Transmitter is not detecting a router. Until this is resolved, the application cannot connect to the spa.

##### *What to do?*

Make sure the router is powered and working correctly (i.e. test it using another computer or device connected to the same LAN port you intend to use).

Make sure the Ethernet cable is correctly connected at each end (LAN port on router end, and the Home Transmitter.) If the problem still occurs, try connecting with another cable. If a computer (or other device) works fine on the LAN port, and the cable is fine, then the Home transmitter is likely defective.

#### GREEN color:

##### *Reason?*

The Home Transmitter is connected to a router (an IP address was assigned), but the in.touch 2 server is not reachable.

##### *What to do?*

This is very likely a router configuration issue, so refer to your router's User Manual.

It may be due to Port 10022 being closed. Normally, this port is open by default in commercial routers, but different routers may have different behaviors.

If Port 10022 is confirmed as open, then some other internal configuration is preventing the router from accessing Internet. In this case, the application will still have access to the hot tub if connected to the same network.

The server may also simply be temporarily "off-line" for servicing/maintenance, so try again later. The application can still connect with the hot tub, but only from within the same network.

If the application can connect to a local spa, the problem is likely the Internet connection (WAN), a router mis-configuration, or your Internet Service Provider (ISP) has issues with its network connection.

#### BLUE color:

##### *Reason?*

This is the normal state of the Home Transmitter LED. It has a full Internet connection, with access to the in.touch 2 server. As long as your device and application have access to the Internet (either via Wi-Fi or cellular data such as 3G, 4G, or LTE), then you're good to go!

##### *What to do?*

Enjoy your hot tub!



## Troubleshooting

---

### Spa Transmitter (CO Module) LED status

This module's LED can show various status conditions, as shown below.

#### **Rapidly flashing YELLOW color:**

The Spa Transmitter is in pairing mode when this color is shown. This normally briefly occurs automatically during power-up of the hot tub (i.e. right after the breaker is flipped on). This could also occur if the Spa Transmitter was never paired (which is very unlikely, as they are shipped paired from factory). Refer to the pairing section if your unit has not been paired, so you may complete the process.

#### **BLUE color:**

##### ***Reason?***

This is the normal state of the Spa Transmitter LED.

If the Spa Transmitter also shows solid blue, you are all set! If this LED is blinking, refer to the Blinking LED section below.

##### ***What to do?***

Enjoy your hot tub!

#### **Blinking LED:**

On both modules, if the LED is blinking about once per second, it means that the RF link is not established between them (i.e. each in.touch 2 module cannot communicate with its counterpart). This can occur for several reasons.

Review the following and perform the tests in the order given below.

##### **Unpaired:**

As the modules are shipped paired from the factory, this is not a likely cause, but it is the easiest test to perform in the field. Simply attempt to pair them again. Please refer to the Pairing section for instructions on pairing.

##### **Modules out of range:**

If the pairing test above does not resolve the problem, then the modules may be too far from each other for an effective RF link. To test this, simply connect the Home Transmitter outside, close to the spa (via an extension cord for power).

A router connection is not needed for this test. If the module LEDs no longer blink, an RF link was established which confirms the hypothesis that the modules were too far apart. Getting the modules closer together somehow is the only solution.

If moving the modules closer together does not stop the LEDs from blinking, attempt to pair them again. If this pairing fails even though the RF modules are near each other, then one or both of the modules are defective, replace them.



## \*Pairing

### Pairing the Spa Transmitter (CO Module) and the Home Transmitter (EN Module)

*Important: New hot tub's from the factory with BIC-e in.touch 2, are shipped with the Spa Transmitter and Home Transmitter already paired.*

*\*The pairing process is only necessary when you need to replace one module of the in.touch 2 kit.*

1. Power up the Home Transmitter

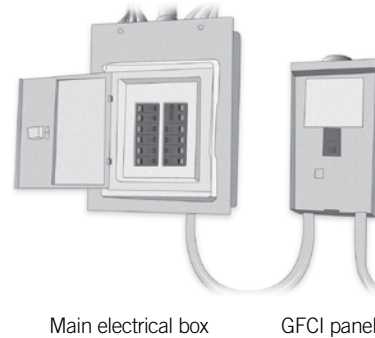
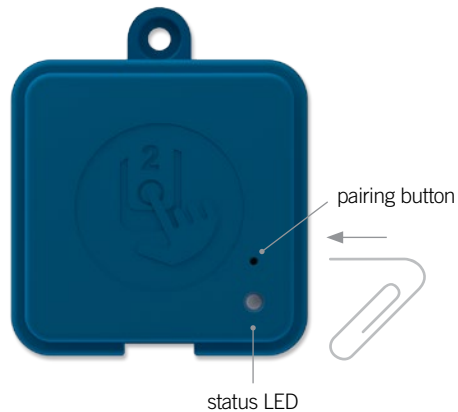

2. Press on the pairing button with a paper clip or some similar tool. When the pairing mode is active the status LED flashes YELLOW in a rapid pattern. The Home Transmitter is then in pairing mode and will remain in this mode until it pairs with an Spa Transmitter, or until it is reset (power cycled).
3. Shut off the hot tub's breaker (thus turning off the Spa Transmitter), wait a few seconds, and then flip the breaker back on. Within a few seconds, the pairing operation should complete and the Home Transmitter status LED will no longer be YELLOW.

**Note:** in.touch 2 modules can be paired as often as necessary, but can only be paired with a single counterpart module at a time. Once paired, the modules store this information permanently until the next pairing operation. Pairing information is stored in non-volatile memory, so pairing is not required after a power failure. Only a Home Transmitter can initiate a pairing, so it is important that the pairing begin with putting the Home transmitter module in pairing mode.

If several hot tubs are powered up at the same time with a Home Transmitter in pairing mode (for instance, in a dealer showroom), only the 1st hot tub to successfully connect to the Home Module will pair. As this can be random, it is recommended that only 1 hot tub be powered up at a time during the pairing process.



---

## Specifications

### Environmental

<b>Humidity:</b>	Up to 85% non condensing
<b>Operating temperature:</b>	-4°F (-20°C) to 140°F (60°C)
<b>Storage temperature:</b>	-22°F (-30°C) to 185°F (85°C)
<b>Water ingress protection:</b>	IPX5 for CO module

### Compatibility

in.yt, in.ye, in.yj, in.xe, or in.xm2 spa systems manufactured in or after 2012.

### Regulatory Compliance Information for Internal Transceiver Module

#### United States

Contains FCC ID: OA3MRF89XAM9A

This equipment has been tested and found to comply with the limits for a Class B digital device, pursuant to part 15 of the FCC Rules. These limits are designed to provide reasonable protection against harmful interference in a residential installation. This equipment generates, uses and can radiate radio frequency energy, and if not installed and used in accordance with the instructions, may cause harmful interference to radio communications. However, there is no guarantee that interference will not occur in a particular installation. If this equipment does cause harmful interference to radio or television reception, which can be determined by turning the equipment off and on, the user is encouraged to try to correct the interference by one or more of the following measures:

- Reorient or relocate the receiving antenna.
- Increase the separation between the equipment and receiver.
- Connect the equipment into an outlet on a circuit different from that to which the receiver is connected.
- Consult the dealer or an experienced radio/TV technician for help.

#### Canada

Contains IC: 7693A-89XAM9A

This device complies with Industry Canada license exempt RSS standard(s). Operation is subject to the following two conditions: (1) this device may not cause interference, and (2) this device must accept any interference, including interference that may cause undesired operation of the device.

#### Europe

The internal transceiver module has been certified for use in European countries. The following tests have been completed, and passed:

Test standard ETSI EN 300 220-2 V2.4.1:

- Frequency error & drift
- Effective radiated power
- Transient power
- Modulation bandwidth
- Unwanted emissions in the spurious domain
- Receiver spurious radiation

Test standard ETSI EN 301 489-3 V1.6.1:

- Conducted emissions
- Radiated emissions
- Radiated immunity



---

## Specifications

### North American compliance

UL 1563 Sixth Ed.

UL file: E182156

CAN/CSA C22.2 No. 218.1-13 (2013)

FCC part 15 (2015) subpart B

ICES-003 (2016)



### European and international compliance

IEC 60335-1, A2 : 2008

IEC 60335-2-60, A1 : 2013

EN 55014-1 : 2006, A1 : 2009, A2 : 2011

EN 55014-2 : 2015

EN 61000-3-2 : 2014

EN 61000-3-3 : 2013



# BIC-e

## Beachcomber Improving Customer's Experience



Beachcomber Hot Tubs  
13245 Comber Way, Surrey BC V3W 5V8 1.866.594.0134  
[www.beachcomberhotubs.com](http://www.beachcomberhotubs.com)



Gecko Alliance  
450 des Canetons, Québec (Qc), G2E 5W6 Canada, 1.800.78.GECKO  
[www.geckoalliance.com](http://www.geckoalliance.com)

9919-101517-G  
Rev. 12-2017

© Groupe Gecko Alliance inc., 2017  
All trademarks or registered trademarks  
are the property of their respective owners.

Printed in Canada